

Exterior Rubber Kit and Components

Chevrolet Truck 1973-87 Crew Cab 1973-89
GMC Truck 1973-87

#38-0792 Super Weatherstrip Adhesive

is fast drying, high strength and waterproof. It is great for bonding all types of truck parts. Dries black.

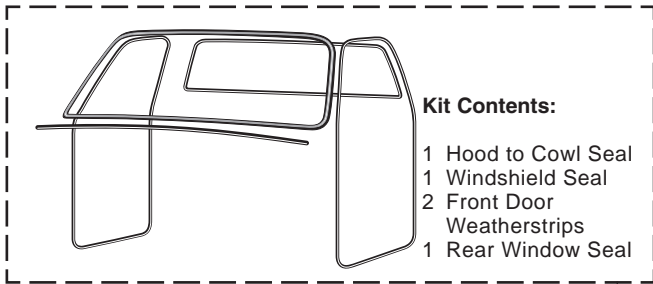

Kit Contents:

- 1 Hood to Cowl Seal
- 1 Windshield Seal
- 2 Front Door Weatherstrips
- 1 Rear Window Seal

Standard Rubber Seals do not have a groove for chrome trim. Custom Rubber Seals do have a groove for chrome trim.

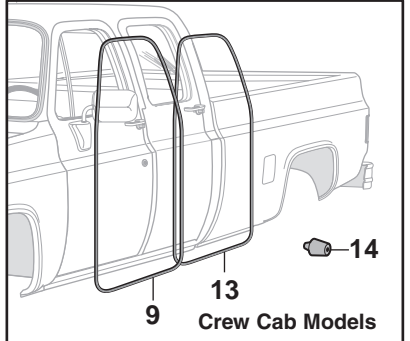
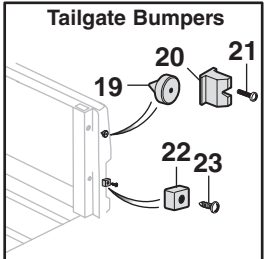
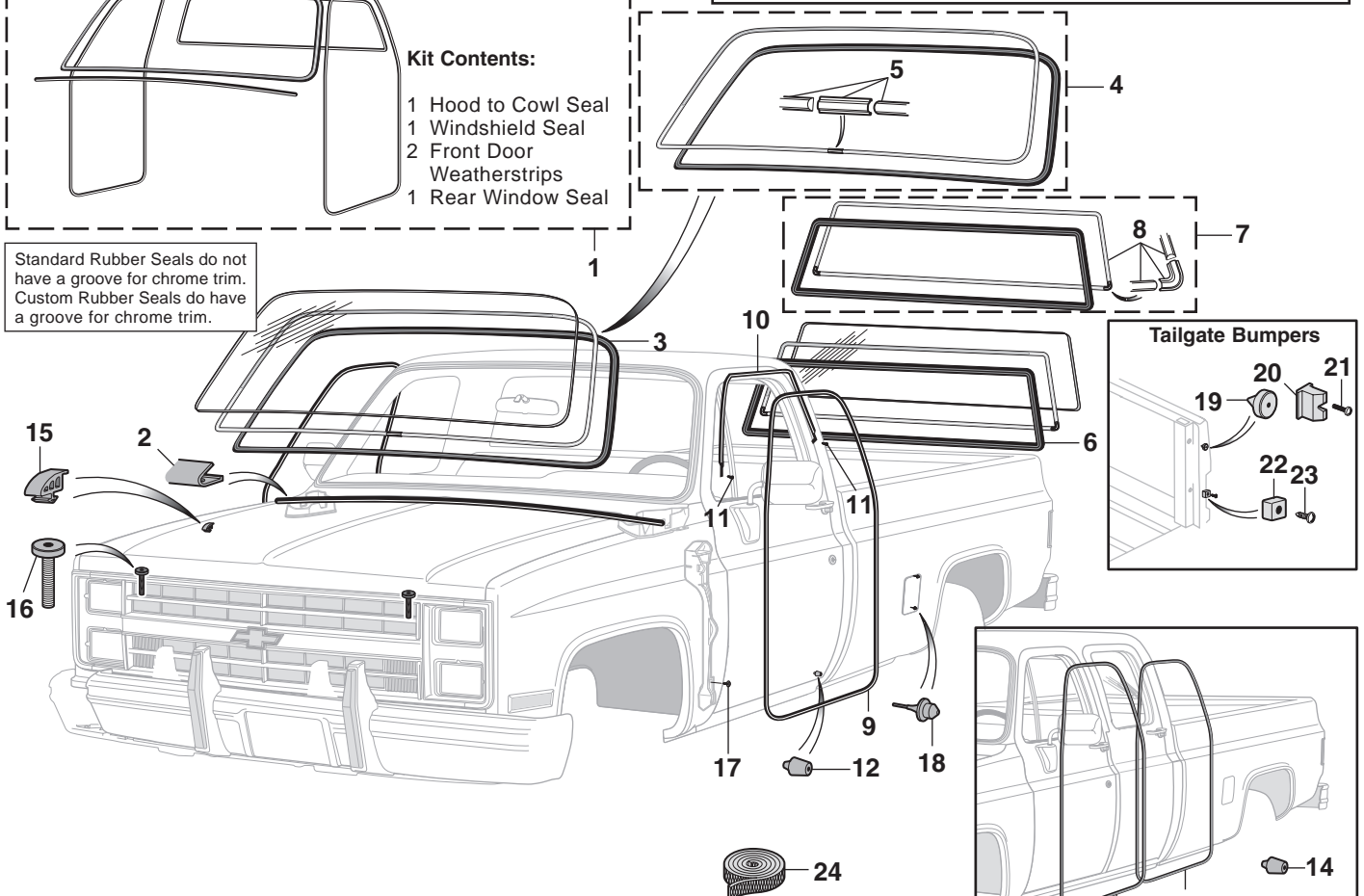

PART	ILL#	DESCRIPTION AND APPLICATION	REQD	LIST	SELL
38-6240	(1)	EXTERIOR RUBBER KIT "A" CHEVY GMC 73-80	(1)	149.94	119.95
38-6241	"B"	EXTERIOR RUBBER KIT CHEVY GMC 73-80	(1)	187.44	149.95
38-6242	"C"	EXTERIOR RUBBER KIT CHEVY GMC 73-80	(1)	174.94	139.95
38-6243		EXTERIOR RUBBER KIT "A" CHEVY GMC 81-87	(1)	149.94	119.95
38-6244		EXTERIOR RUBBER KIT "B" CHEVY GMC 81-87	(1)	187.44	149.95
38-6245		EXTERIOR RUBBER KIT "C" CHEVY GMC 81-87	(1)	174.94	139.95
38-7408	(2)	SEAL-HOOD TO COWL CHEVY GMC 73-80	(1)	13.69	10.95
38-7405		SEAL-HOOD TO COWL CHEVY GMC 81-87	(1)	16.19	12.95
38-5911	(3)	WINDSHIELD RUBBER-STANDARD CHEVY GMC 73-87	(1)	49.94	39.95
38-5900		WINDSHIELD RUBBER-CUSTOM CHEVY GMC 73-87	(1)	49.94	39.95
38-5913	(4)	RUBBER KIT W/CHROME TRIM CHEVY GMC 73-87	(1)	62.44	49.95
38-5915		RUBBER KIT W/BLACK TRIM CHEVY GMC 73-87	(1)	62.44	49.95
38-6032	(5)	TRIM KIT-CHROME CHEVY GMC 73-87	(1)	24.94	19.95
38-6033		TRIM KIT-BLACK CHEVY GMC 73-87	(1)	21.19	16.95
38-5917	(6)	REAR WINDOW RUBBER-STD CHEVY GMC 73-87	(1)	37.44	29.95
38-5919		REAR WINDOW RUBBER-CUSTOM CHEVY GMC 73-87	(1)	49.94	39.95
38-6007	(7)	RUBBER KIT W/CHROME TRIM CHEVY GMC 73-87	(1)	62.44	49.95
38-6034	(8)	TRIM KIT-CHROME CHEVY GMC 73-87	(1)	24.94	19.95
38-5952	(9)	DOOR WEATHERSTRIP-ON CAB CHEVY GMC 73-87	(2)	37.44	29.95
38-6948	(10)	DOOR WEATHERSTRIP-ONDOOR-LH CHEVY GMC 79-81	(1)	43.69	34.95
38-6949		DOOR WEATHERSTRIP-ONDOOR-RH CHEVY GMC 79-81	(1)	43.69	34.95
30-0592	(11)	SCREW-WEATHERSTRIP CHEVY GMC 79-81	(4)	.63	.50
30-1820	(12)	DOOR BUMPER CHEVY GMC 73-87	(2)	2.44	1.95
38-5952	(13)	REAR DOOR WEATHERSTRIP-BODY CREW CAB	73-78 (2)	37.44	29.95
38-6988		REAR DOOR WEATHERSTRIP-BODY CREW CAB	79-89 (2)	37.44	29.95
30-1820	(14)	DOOR BUMPER	CREW CAB 73-89 (4)	2.44	1.95
30-1822	(15)	HOOD BUMPER-SIDE	CHEVY GMC 73-87 (6)	2.44	1.95
30-1824	(16)	HOOD BUMPER-FRONT	CHEVY GMC 73-81 (2)	4.94	3.95
30-1826		HOOD BUMPER-FRONT	CHEVY GMC 82-87 (2)	4.94	3.95
30-0959	(17)	SCREW-FRONT FENDER SEAL	CHEVY GMC 81-87 (8)	3.69	2.95
30-1840	(18)	FUEL DOOR BUMPER	CHEVY GMC 79-87 2/4	3.69	2.95
30-1810	(19)	TAILGATE BUMPER-UPPER	CHEVY GMC 73-80 (2)	3.69	2.95
30-1815	(20)	TAILGATE BUMPER-UPPER	CHEVY GMC 81-87 (2)	6.19	4.95
30-0414	(21)	SCREW	CHEVY GMC 81-87 (2)	1.19	.95
30-1811	(22)	TAILGATE BUMPER-LOWER	CHEVY GMC 73-87 (2)	3.69	2.95
30-0507	(23)	SCREW	CHEVY GMC 73-87 (2)	.81	.65
38-7460	(24)	BODY TO FRAME WEBBING 30FT	CHEVY GMC 73-87 (1)	31.19	24.95
38-0792		SUPER ADHESIVE-BLACK	5 OUNCE TUBE	7.44	5.95

Note: "A" Standard windshield and rear window rubber without trim.
"B" Custom windshield and rear window rubber with chrome trim.
"C" Custom windshield rubber with black trim and Custom rear window rubber without trim.

Tailgate Sealer

Tailgate Sealer keeps out water, dirt, wind and exhaust fumes. Excellent for use with camper shells and tonneaus. Made from high-quality EDPM rubber with easy peel-and-stick installation.

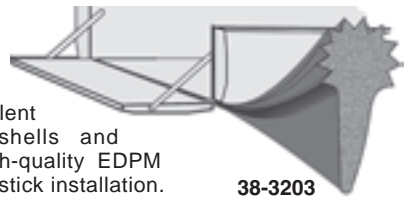

38-3203

38-3203 TAILGATE SEALER 24.94 19.95

Windshield and Rear Window Installation Tips:

1. Fit your new window rubber to your cab first, then install the window glass.
2. Use a rubber friendly lubricant such as WD40 and the Windshield Stick (#38-0796) to ease installation and avoid damaging your window rubber.
3. Window rubber shrinks; your new window rubber may appear slightly larger than the original prior to installation.



TINTED Windshield has a full light green tint to glass.



SHADED Windshield has a full light green tint with a dark band at the top of glass.

Windshield Stick A glass installer's most useful tool! Can be used to install or remove windows or window rubber. This plastic tool measures 8" in length for an easy grip.



38-0796

Windshield and Glass Sealant is silicone and seals windshields, windows, sunroofs and more. Flows into leaks like water but dries to form a flexible, tough, clear seal resistant to extreme temperatures, vibration, shock and most chemicals.



38-0783

STANDARD = Standard Rubber Seals do not have groove for chrome trim.
CUSTOM = Custom Rubber Seals do have a groove for chrome trim.

Windshield and Seal

Chevrolet Truck 1973-87 Crew Cab 1973-89
GMC Truck 1973-87

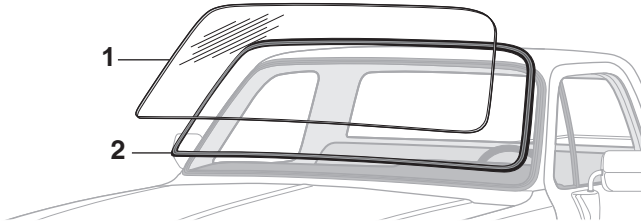

-T after a part number means that part must be shipped Truck Freight. The prepaid order will include a \$125.00 charge for delivery in the 48 contiguous United States. Orders outside of the 48 states will be quoted.

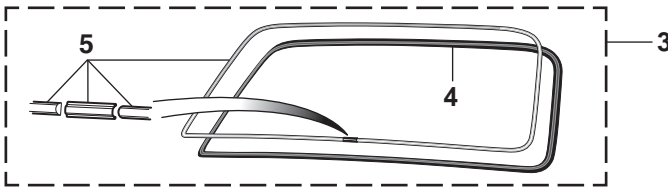

PART	ILL#	DESCRIPTION AND APPLICATION	REQD	LIST	SELL
38-9425-T	(1)	WINDSHIELD-CLEAR CHEVY GMC 73-87	(1)	162.44	129.95
38-9421-T	(1)	WINDSHIELD-SHADED CHEVY GMC 73-87	(1)	162.44	129.95
38-9427-T	(1)	WINDSHIELD-CLEAR W/ANTENNA CHEVY GMC 73-87	(1)	162.44	129.95
38-9423-T	(1)	WINDSHIELD-SHADED W/ANTENNA CHEVY GMC 73-87	(1)	162.44	129.95
38-5911	(2)	WINDSHIELD RUBBER-STANDARD CHEVY GMC 73-87	(1)	49.94	39.95
38-5913	(3)	WINDSHIELD RUBBER KIT WITH CHROME TRIM CUSTOM CHEVY GMC 73-87	(1)	62.44	49.95
38-5915	(3)	WINDSHIELD RUBBER KIT WITH BLACK TRIM CUSTOM CHEVY GMC 73-87	(1)	62.44	49.95
38-5900	(4)	WINDSHIELD RUBBER-CUSTOM CHEVY GMC 73-87	(1)	49.94	39.95
38-6032	(5)	TRIM KIT-CHROME CHEVY GMC 73-87	(1)	24.94	19.95
38-6033	(5)	TRIM KIT-BLACK CHEVY GMC 73-87	(1)	21.19	16.95
38-0783		SILICONE SEALANT WINDSHIELD & GLASS 1.5 OZ TUBE		6.19	4.95
38-0796		WINDSHIELD STICK CHEVY GMC 73-87	(1)	2.44	1.95

Rear Window and Seal

Chevrolet Truck 1973-87 Crew Cab 1973-89
GMC Truck 1973-87

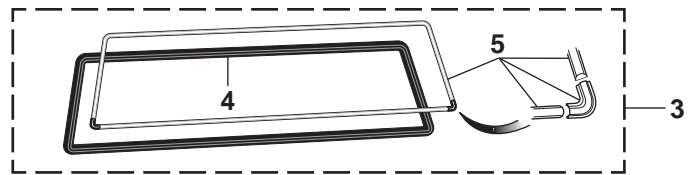
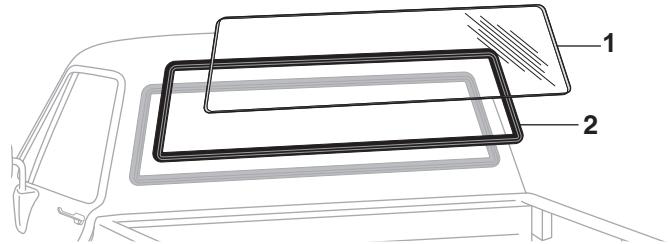

Standard Rubber Seals do not have a groove for chrome trim.
 Custom Rubber Seals do have a groove for chrome trim.

*After the sell price means Oversize Part Charge. Your order will incur a charge of \$20.00 for each oversized part.

PART	ILL#	DESCRIPTION AND APPLICATION	REQD	LIST	SELL
38-6008	(1)	REAR WINDOW-CLEAR CHEVY GMC 73-75	(1)	99.94	79.95 *
38-6004	(1)	REAR WINDOW-TINTED CHEVY GMC 73-75	(1)	124.94	99.95 *
38-6006	(1)	REAR WINDOW-CLEAR CHEVY GMC 76-87	(1)	99.94	79.95 *
38-6002	(1)	REAR WINDOW-TINTED CHEVY GMC 76-87	(1)	99.94	79.95 *
38-5917	(2)	REAR WINDOW RUBBER-STANDARD CHEVY GMC 73-87	(1)	37.44	29.95
38-6007	(3)	REAR WINDOW RUBBER KIT WITH CHROME TRIM CUSTOM CHEVY GMC 73-87	(1)	62.44	49.95
38-5919	(4)	REAR WINDOW RUBBER-CUSTOM CHEVY GMC 73-87	(1)	49.94	39.95
38-6034	(5)	TRIM KIT-CHROME CHEVY GMC 73-87	(1)	24.94	19.95
38-0783		SILICONE SEALANT WINDSHIELD & GLASS 1.5 OZ TUBE		6.19	4.95
38-0796		WINDSHIELD STICK CHEVY GMC 73-87	(1)	2.44	1.95

Double Black Film Kit

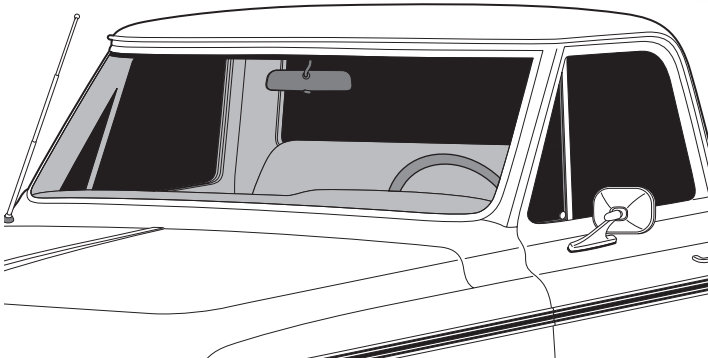

38-0270

With the Double Black Film Kit you can ride in your truck without being bothered by the rest of the world. Customize your truck with an easy-to-install Double Black Film Kit with self-adhesive backing. The 20" x 60" kit offers the maximum protection from the sun coming in through your truck's rear window. Double Black Film Kit makes glass more shatter resistant. Film kit allows 5% light transmission.

Check state and local laws before ordering.

PART	DESCRIPTION AND APPLICATION	LIST	SELL
38-0270	DOUBLE BLACK WINDOW FILM KIT 20 X 60 ROLL	18.69	14.95